

KOHLER[®] COURAGE XT-6, XT-7, XTR-7



XT-6, XT-7, XTR-7 VERTICAL CRANKSHAFT OWNER'S MANUAL

EN

XT-6, XT-7, XTR-7 CIGÜEÑAL VERTICAL MANUAL DEL USUARIO

ES

XT-6, XT-7, XTR-7 VILEBREQUIN VERTICAL MANUEL DE PROPRIÉTAIRE

FR

KOHLER[®]
ENGINES

Table of Contents

Safety Precautions	2-3	Angle of Operation	9
Oil Recommendations	5	Overheating	9
Oil Type.....	5	Carburetor	9
Fuel Recommendations	5	Maintenance	9
General Fuel Recommendations.....	5	Maintenance Instructions.....	10
Fuel Type.....	5	Oil Level Check	10
Fuel Line.....	6	Oil Change	11
Fuel Shut-off Valve (If Equipped).....	6	Air Cleaner System	11
Fuel Filter (If Equipped)	6	Paper Air Filter	11
Engine Identification Numbers	6	Foam Air Filter	12
Serial Number.....	7	Precleaner	12
Emission Compliance	7	Cooling Areas	12
Emission Compliance Period.....	7	Spark Plug	12
Operating Instructions	7	Ignition	13
Pre-Start Checklist.....	7	Repairs	13
Cold Weather Starting	7	Engine Specifications	13
Smart-Choke™ (If Equipped).....	7	Parts Ordering	13
Electric Start (XTR-7 Only)	8	Troubleshooting	14
Recoil Start	8	Storage	14
Primer Bulb Start (If Equipped).....	8	Engine Warranties	15-17
Manual Choke Start.....	8		
Shutdown Engine	9		
Engine Speed	9		

Safety Precautions

To ensure safe operation, please read the following statements and understand their meaning. Also refer to your equipment owner's manual for other important safety information. This safety precautions contained in this manual are explained below:

WARNING

Warning is used to indicate the presence of a hazard that *can* cause *severe* personal injury, death, or substantial property damage if the warning is ignored.

CAUTION

Caution is used to indicate the presence of a hazard that *will* or can cause *minor* personal injury or property damage if the caution is ignored.

NOTE

Note is used to notify people of installation, operation, or maintenance information that is important but not hazard-related.

For Your Safety!

These precautions should be followed at all times. Failure to follow these precautions could result in injury to the operator and others.

Safety Precautions

⚠ WARNING

<p>Explosive Fuel can cause fires and severe burns.</p> <p>Do not fill the fuel tank while the engine is hot or running.</p>

Explosive Fuel!

Gasoline is extremely flammable and its vapors can explode if ignited. Store gasoline only in approved containers, in well ventilated, unoccupied buildings, away from sparks or flames. Do not fill the fuel tank while the engine is hot or running, since spilled fuel could ignite if it comes in contact with hot parts or sparks from ignition. Do not start the engine near spilled fuel. Never use gasoline as a cleaning agent.

⚠ WARNING

<p>Hot Parts can cause severe burns.</p> <p>Do not touch engine while operating or just after stopping.</p>

Hot Parts!

Engine components can get extremely hot from operation. To prevent severe burns, do not touch these areas while the engine is running, or immediately after it is turned off. Never operate the engine with heat shields or guards removed.

⚠ WARNING

<p>Carbon Monoxide can cause severe nausea, fainting or death.</p> <p>Avoid inhaling exhaust fumes, and never run the engine in a closed building or confined area.</p>

Lethal Exhaust Gases!

Engine exhaust gases contain poisonous carbon monoxide. Carbon monoxide is odorless, colorless, and can cause death if inhaled. Avoid inhaling exhaust fumes, and never run the engine in a closed building or confined area.

⚠ WARNING

<p>Accidental Starts can cause severe injury or death.</p> <p>Disconnect and ground spark plug lead before servicing.</p>

Accidental Starts!

Accidental starting can cause severe injury or death. Before working on the engine or equipment, disable the engine by disconnecting the spark plug lead.

⚠ CAUTION

<p>Electrical Shock can cause injury.</p> <p>Do not touch wires while engine is running.</p>

Electrical Shock!

Never touch electrical wires or components while the engine is running. They can be sources of electrical shock.

⚠ WARNING

<p>Rotating Parts can cause severe injury.</p> <p>Stay away while engine is in operation.</p>

Rotating Parts!

Keep hands, feet, hair, and clothing away from all moving parts to prevent injury. Never operate the engine with covers, shrouds, or guards removed.

California Proposition 65 Warning
<p><i>Engine exhaust from this product contains chemicals known to the State of California to cause cancer, birth defects, or other reproductive harm.</i></p>

EN

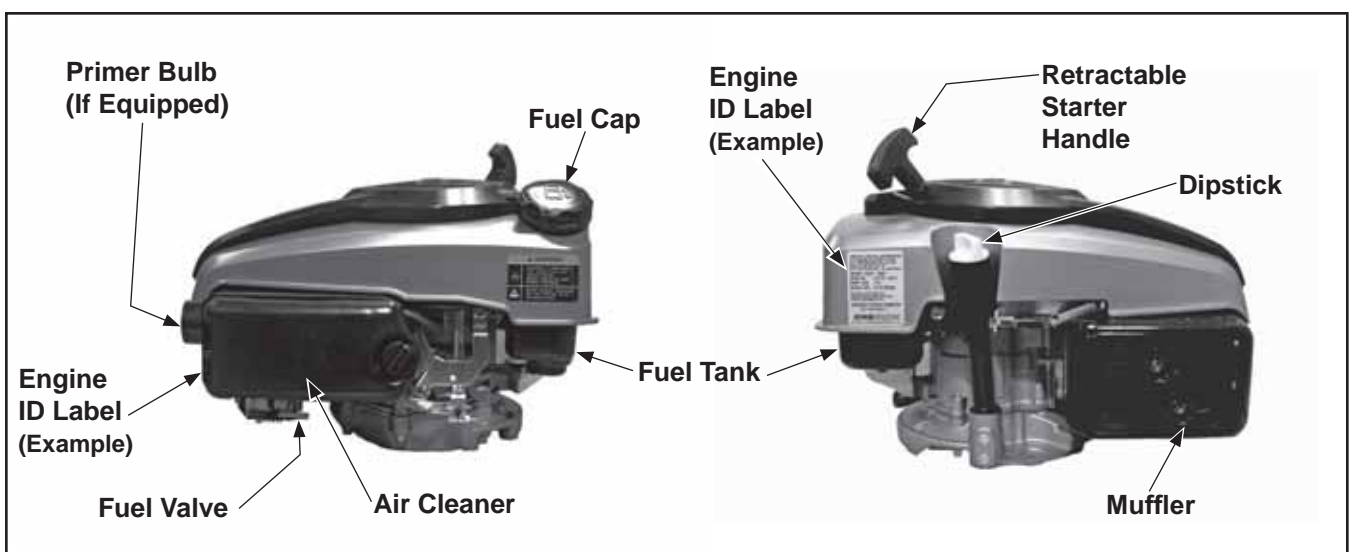

Figure 1. Courage XT-7, Vertical Shaft Engine.

Oil Recommendations

Using the proper type and weight of oil in the engine is extremely important, as is daily checking of oil level and changing oil regularly. Failure to use the correct oil, or using dirty oil, will cause premature engine wear and failure. Refer to Oil Check/Change maintenance instructions.

Oil Type

Use high-quality oil that ranks at or above the American Petroleum Institute's (API) SJ service class. Select the oil's viscosity based on air temperature at the time of operation, as shown in Figure 2.

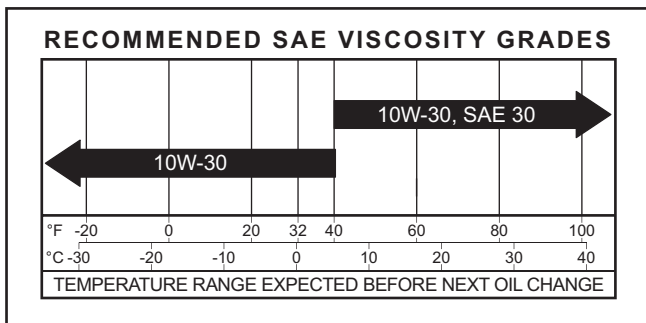

Figure 2. Viscosity Grades Table.

Use service class SJ rated oil or higher. Do not extend the oil change intervals longer than recommended as this can cause engine damage, and may void the warranty. An API symbol on the oil container identifies the service class and SAE viscosity grade. See Figure 3.

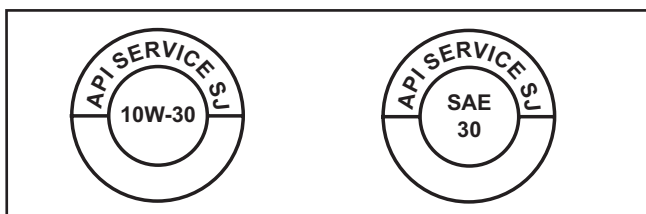

Figure 3. Oil Container Logos.

Fuel Recommendations

⚠ WARNING: Explosive Fuel!

Gasoline is extremely flammable and its vapors can explode if ignited. Store gasoline only in approved containers, in well ventilated, unoccupied buildings, away from sparks or flames. Do not fill the fuel tank while the engine is hot or running since spilled fuel could ignite if it comes in contact with hot parts or sparks from ignition. Do not start the engine near spilled fuel. Never use gasoline as a cleaning agent.

General Fuel Recommendations

Purchase gasoline in small quantities and store in clean, approved containers. Use a container with a capacity of two gallons or less with a pouring spout is recommended, as it is easier to handle and helps eliminate spillage during refueling. To minimize gum deposits in fuel system, do not use gasoline left over from previous season. Do not add oil to the gasoline. Do not overfill the fuel tank. Leave room for the fuel to expand.

Fuel Type

For best results use only clean, fresh, unleaded gasoline with an octane rating of 87 or higher. In countries using the Research method, it should be 90 octane minimum.

Unleaded gasoline is recommended as it leaves less combustion chamber deposits. Leaded gasoline may be used in areas where unleaded is not available and exhaust emissions are not regulated. Be aware that the cylinder head may require more frequent service.

Gasoline/Alcohol Blends

Gasohol (up to 10% ethyl alcohol, 90% unleaded gasoline by volume) is approved as a fuel for Kohler engines. Other gasoline/alcohol blends including E20 and E85 should not be used. Failures resulting from use of these fuels will not be warranted.

EN

Gasoline/Ether Blends

Methyl Tertiary Butyl Ether (MTBE) and unleaded gasoline blends (up to a maximum of 15% MTBE by volume) are approved as a fuel for Kohler engines. Other gasoline/ether blends are not approved.

Fuel Line

These engines use Low Permeation SAE 30 R7 rated fuel lines, certified to meet emission requirements. Standard fuel line may not be used. Order replacement hose (Kohler part number 25 111 40-S) through a Kohler authorized service center.

Fuel Shut-off Valve (If Equipped)

Turn to ON fuel flow, rotate fuel shut-off valve towards the engine. To turn OFF the fuel flow, rotate the fuel shut-off valve away from the engine. See Figure 4.

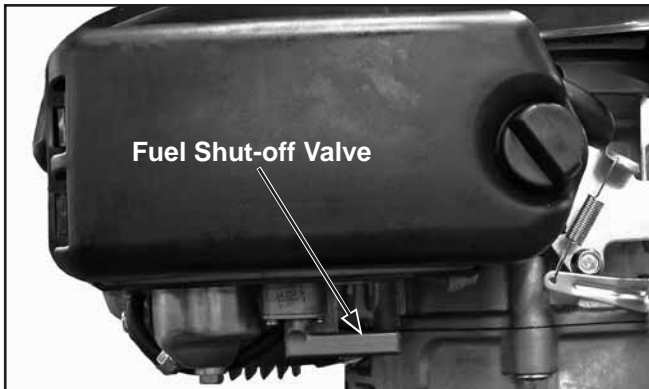

Figure 4. Fuel Shut-off Valve (ON Position Shown).

NOTE: Before transporting the engine, ensure the fuel valve is in the OFF position to prevent fuel spillage.

Fuel Filter (If Equipped)

Replace with a Kohler fuel filter yearly or every 50 hours of operation (Kohler part number 14 050 16-S). Removing the air filter will allow easy access to the fuel filter for servicing. See Figure 5.

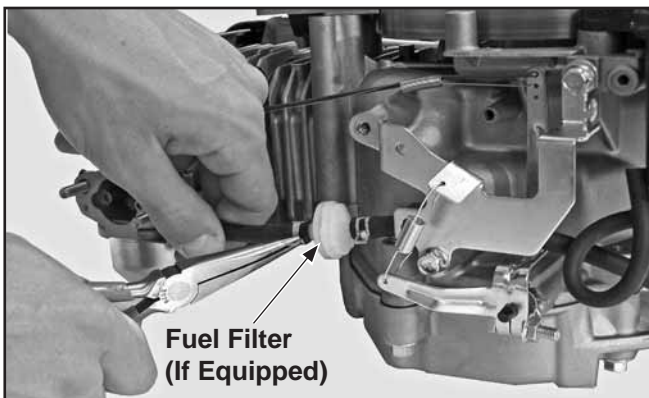

Figure 5. Fuel Filter (Air Filter Removed).

Engine Identification Numbers

Engine identification numbers will appear on one of several variations of labels affixed to the engine. See Figures 6 and 7. See Figure 1 for Engine Identification Label locations.

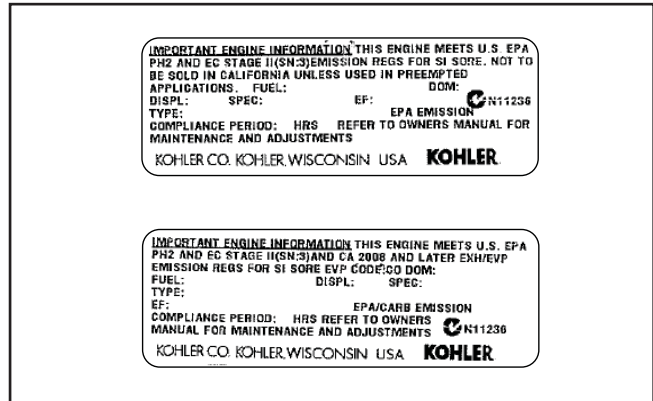

Figure 6. Air Cleaner Housing Labels (Samples).

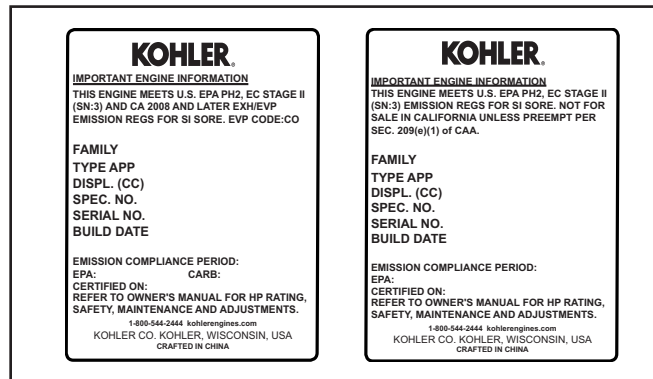

Figure 7. Engine Shrouding Labels (Samples).

When ordering parts, or in any communication concerning this engine, always give the model name, specification number, and serial number — including any letter suffixes.

Record all engine ID numbers for future reference.

Serial Number

The serial number is etched into the engine block, directly below the fuel tank. When ordering parts, or in any communication, always provide model, specification number, and serial number. Record the serial number for future reference. See Figure 8.

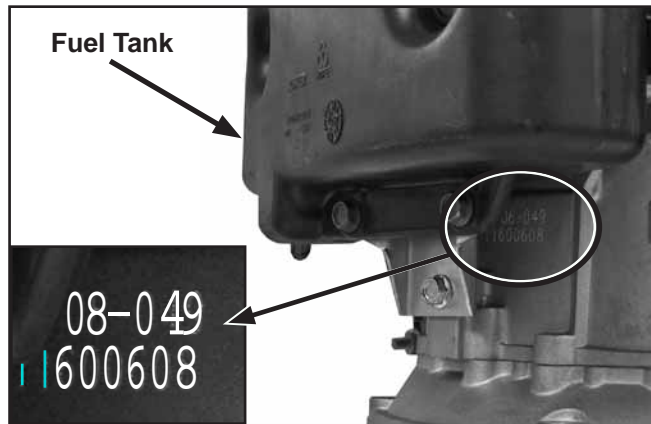

Figure 8. Serial Number Location.

Additional engine identification numbers can be found on the engine ID labels. See Figures 6 and 7.

Emission Compliance

The Emission Compliance Period, referred to on the Emission Control or Air Index label, indicates the number of operating hours for which the engine has been shown to meet Federal and CARB emission requirements. The hourly engine compliance period associated with the category description is located on the identification label. See Figure 9.

Emission Compliance Period	
EPA	Category C - 125 hours
CARB	Moderate - 125 hours

Figure 9. Emission Compliance Table.

For engine displacement information, refer to Figure 6, 7 or Figure 20 (specifications).

Exhaust Emission Control System for models XT-6, XT-7, and XTR-7 is EM.

Operating Instructions

In addition to these instructions, also read the instructions of equipment this engine powers.

Pre-Start Checklist

1. Check oil level; if low add oil. Do not overfill.
2. Check fuel level; if low add fuel. Do not overfill.
3. Check cooling areas, air intake areas, and external surfaces of engine. Make sure they are clean and unobstructed.
4. Check that the air cleaner components and all shrouds, equipment covers, and guards are in place and securely fastened.



WARNING: Lethal Exhaust Gases!

Engine exhaust gases contain poisonous carbon monoxide. Carbon monoxide is odorless, colorless, and can cause death if inhaled. Avoid inhaling exhaust fumes, and never run the engine in a closed building or confined area.

Cold Weather Starting

Use the proper oil for the air temperature expected. See Viscosity Table.

1. Use fresh winter grade fuel. Winter grade gasoline has higher volatility to improve starting. Do not use gasoline left over from summer.
2. Ensure the battery (on XTR-7 only) is in good condition. A warm battery has much more starting capacity than a cold battery.

Smart-Choke™ (If Equipped)

1. Move fuel shut-off valve to the **ON** position (if equipped). Refer to Figure 4.
2. Turn the ignition switch to the **ON** position. Refer to the operating instructions of the equipment this engine powers.
3. For Smart-Choke™ (auto choke) engines, start-up adjustments are not necessary or possible.
4. Once engine starts, adjust it to the equipment manufacturer's recommended operating speed (if adjustable).

Electric Start (XTR-7 Only)

1. Move fuel shut-off valve to the **ON** position (if equipped). Refer to Figure 4.
2. Turn the ignition switch to the **ON** position (if equipped). Refer to the operating instructions of the equipment this engine powers.
3. Start the engine by activating key switch; release as soon as engine starts.

NOTE: Do not crank the engine continuously for more than 5 seconds at a time. If the engine does not start, wait 30 seconds before attempting to restart. Failure to follow these guidelines may damage or overheat the starter motor.

4. Once the engine starts, adjust it to the equipment manufacturer's recommended operating speed (if adjustable).

Recoil Start

1. Move the fuel shut-off valve to the **ON** position (if equipped). Refer to Figure 4.
2. Turn the ignition switch to the **ON** position (if equipped). Refer to the operating instructions of the equipment this engine powers.
3. Pull the starter handle straight out with a smooth, steady motion.

NOTE: Extend the starting rope periodically and check its condition. If the rope is frayed, have it replaced immediately by a Kohler Authorized Service Center.

4. Once engine starts, adjust it to the equipment manufacturer's recommended operating speed (if adjustable).



WARNING: Accidental Starts!

Before extending and checking the retractable starter rope, remove the spark plug lead to prevent the engine from starting accidentally.

Primer Bulb Start (If Equipped)

1. Move fuel shut-off valve to the **ON** position (if equipped). Refer to Figure 4.
2. Turn the ignition switch to the **ON** position. Refer to the operating instructions of the equipment this engine powers.
3. When the outside temperature is above 55°F (13°C), press **CENTER** of primer bulb three times before starting. When outside temperature is below 55°F (13°C), press **CENTER** of primer bulb five times before starting. See Figures 10 and 11.

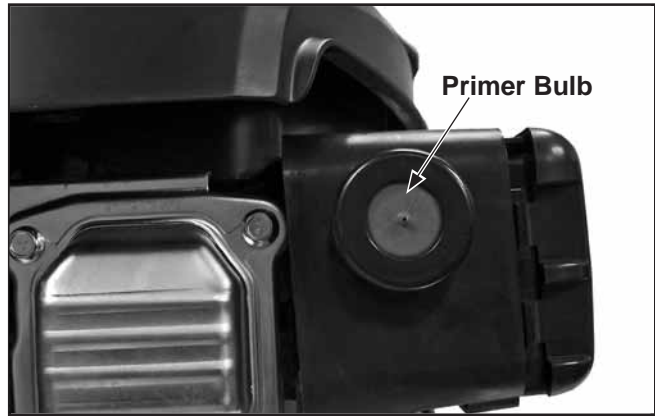

Figure 10. Primer Bulb.

Cold Engine: Start as follows

Outside temperature above 55°F (13°C)	Primer	Choke
	3 pumps	ON
Outside temperature below 55°F (13°C)	Primer	Choke
	5 pumps	ON

Warm Engine: Do not use primer

Figure 11. Primer Bulb Quick Reference Table.

NOTE: It is important to press the **CENTER** of the red primer bulb so the air hole is covered, ensuring proper pressure.

NOTE: Pressing the primer bulb more times than recommended will flood engine, making starting more difficult.

4. Once the engine starts, adjust it to the equipment manufacturer's recommended operating speed (if adjustable).
5. To restart a warm engine, no priming is required.

Manual Choke Start

1. Move fuel shut-off valve to the **ON** position (if equipped). Refer to Figure 4.
2. Turn the ignition switch to **ON** (refer to the operating instructions of the equipment this engine powers).
3. Turn the ignition switch to **ON** (refer to the operating instructions of the equipment this engine powers).
4. To start a cold engine, move throttle/choke lever to **FAST/CHOKE ON** position. To start a warm engine, no choke is required.

Shutdown Engine

To shutdown the engine, turn ignition switch to **OFF** position (if equipped). Move the fuel shut-off lever to **OFF** position (if equipped). See Figure 4.

NOTE: If the engine is equipped with an optional blade-brake clutch (BBC), the blade can be stopped without shutting down the engine. For further information, refer to operating instructions of the equipment this engine powers.

Engine Speed

Unless the equipment this engine is mounted on has a variable-speed control (throttle), the speed of this engine cannot be altered.

NOTE: Do not tamper with governor or carburetor to increase engine speed. Overspeed is hazardous and will void warranty.

Angle of Operation

This engine will operate continuously at angles up to 20°, and intermittently up to 25° in all directions for one minute or less. Oil level must be at **FULL** mark on dipstick. Refer to the operating instructions of the equipment this engine powers. Due to equipment design or application, there may be more stringent restrictions regarding the angle of operation.

NOTE: Do not operate this engine continuously at angles exceeding 20° in any direction, because engine damage could result from insufficient lubrication.

Overheating

To avoid engine damage due to overheating remove grass and other built-up debris after each use.

NOTE: After running the engine for any length of time, allow it to cool down sufficiently before attempting to clean off debris.



WARNING: Hot Parts!

Engine components can get extremely hot from operation. To prevent severe burns, do not touch these areas while the engine is running, or immediately after it is turned off. Never operate the engine with heat shields or guards removed.

Carburetor

The carburetor is designed to deliver the correct fuel-to-air mixture to the engine under all operating conditions. It has been calibrated at the factory and is not adjustable.

NOTE: To ensure correct engine operation at altitudes above 1525 meters (5000 ft.), it may be necessary to have a Kohler Authorized Service Center install a high-altitude jet kit. If a high-altitude kit has been installed, the engine must be reconverted to the original jet size before it is operated at lower altitudes, or overheating and engine damage may result.

If engine troubles appear to be fuel-system related, check the following areas before seeking service from a Kohler Authorized Service Center.

- Ensure the fuel tank is filled with clean, fresh gasoline.
- Ensure the air cleaner and precleaner are clean and securely fastened.
- Ensure the fuel tank cap vent is not blocked and that it is operating properly.
- Ensure the in-line fuel filter, if equipped, is clean and unobstructed. Replace if necessary.

If after checking these items the engine is still hard to start, runs roughly, or stalls at low-idle speed, it may be necessary to have the carburetor serviced by a Kohler Authorized Service Center.

Maintenance

Maintenance, repair or replacement of the emission control devices and systems, which are done at the customer's expense, may be performed by any non-road engine repair establishment or individual. Warranty repairs must be performed by a Kohler Authorized Service Center. Required maintenance procedures should be performed at the frequency outlined in Figure 12.



WARNING: Accidental Starts

Accidental starting can cause severe injury or death. Before working on the engine or equipment, disable the engine by disconnecting the spark plug lead.

EN

Maintenance Instructions

Frequency	Maintenance Required
After First 3-5 Hours of Operation	Change oil
Daily or Before Starting Engine	Fill fuel tank
	Check oil level.
	Check air intake and cooling areas; clean as necessary ¹
Yearly or Every 25 Hours	Service or replace precleaner element (if equipped) ¹
	Check paper air or foam filters for dirty, loose or damaged parts ¹
Yearly or Every 50 Hours	Replace fuel filter (if equipped)
	Change oil
Yearly or Every 100 hours	Replace spark plug and set gap
	Replace paper air filter ¹
	Replace foam air filter
	Adjust valves ²
	Clean combustion chamber ²

Figure 12. Maintenance Table.

¹Perform these maintenance procedures more frequently under extremely dusty, dirty conditions.

²These procedures should be performed by a Kohler Authorized Service Center.

Oil Level Check

The importance of checking and maintaining the proper oil level in the crankcase cannot be overemphasized.

Check oil **BEFORE EACH USE** as follows:

1. Make sure the engine is stopped, level, and cool so the oil has had time to drain into the sump.
2. Clean the area around the oil fill cap/dipstick to keep dirt and grass clippings out of the engine.
3. Unscrew and remove the oil fill cap/dipstick; wipe off oil. Reinsert the dipstick into the tube and rest the oil fill cap on the tube. **DO NOT** screw the cap into the tube. See Figure 13.

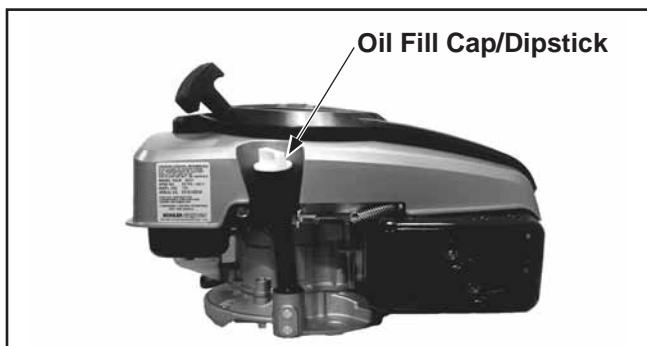

Figure 13. Oil Fill Cap/Dipstick.

4. Remove dipstick again and check oil level. Oil should be up to, but not over **F** or **FULL** mark on dipstick. See Figure 14.

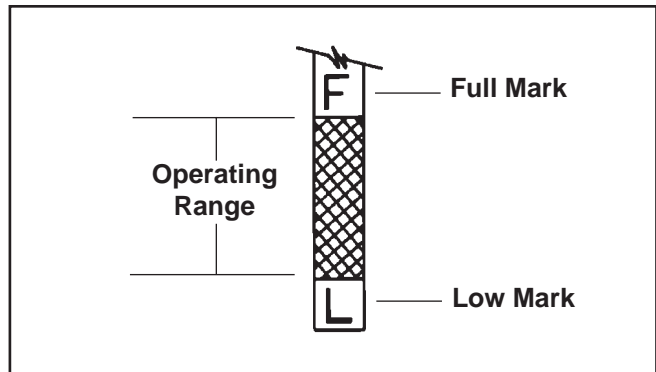

Figure 14. Oil Level Dipstick.

5. If oil level is low, add the correct type of oil up to the **F** or **FULL** mark on dipstick. Always check the oil level with the dipstick before adding more.
6. Reinstall oil fill cap/dipstick and tighten securely.

NOTE: To prevent extensive engine wear or damage, always maintain proper oil level in crankcase. Never operate engine with oil level below the **L** or **LOW** mark, or over the **F** or **FULL** mark on dipstick.

Oil Change

Oil can be changed by either draining it from the dipstick tube, or from the optional drain plug. Change the oil after the first three to five hours of operation. After that, change the oil yearly or after every 50 hours of operation. Change oil while engine is still warm, and refill according to the Viscosity Grades Table.

Drain Oil from Dipstick Tube

1. To keep dirt, grass clippings, etc., out of the engine, clean the area around the oil fill cap/dipstick; remove the oil fill cap/dipstick.
2. Tilt the engine on its side with the air cleaner facing up. See Figure 15. Drain oil into approved container.

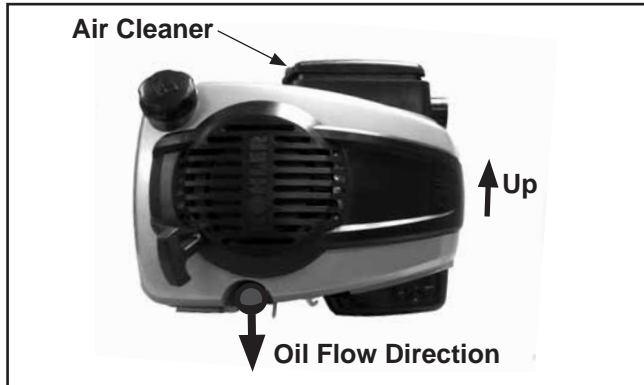

Figure 15. Engine Tilted onto Side, Air Cleaner Up.

3. After the crankcase is completely drained, tilt the engine back upright.
4. Fill the crankcase with new oil of the proper type to the **FULL** mark on the dipstick. See Figure 14. Recheck oil level before adding more oil. Do not screw dipstick in when checking oil level.
5. Reinstall the oil fill cap/dipstick; tighten securely.

Drain Oil Via Crankcase Plug (If Accessible)

1. Disable engine by disconnecting spark plug.
2. Remove crankcase plug on bottom of engine and drain oil into approved container. See Figure 16.

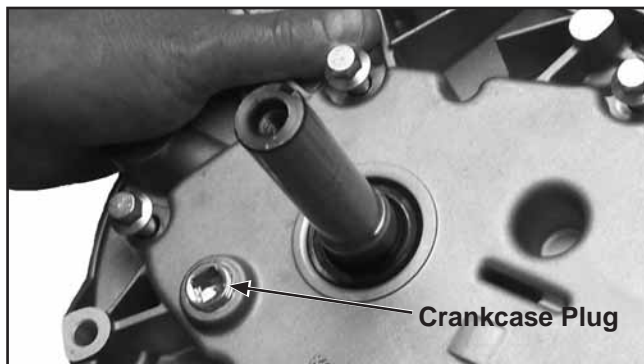

Figure 16. Crankcase Plug.

NOTE: Oil will drain easier and more quickly if the dipstick is removed.

3. Apply thread sealant around three full threads of the drain plug, and reinstall the drain plug; torque to 13.6 N·m (120 in. lb.).

Air Cleaner System

This engine is equipped with either a replaceable, high density paper air filter, or a foam air filter, depending on the application. In addition, an optional foam precleaner may also be included. See Figure 17.

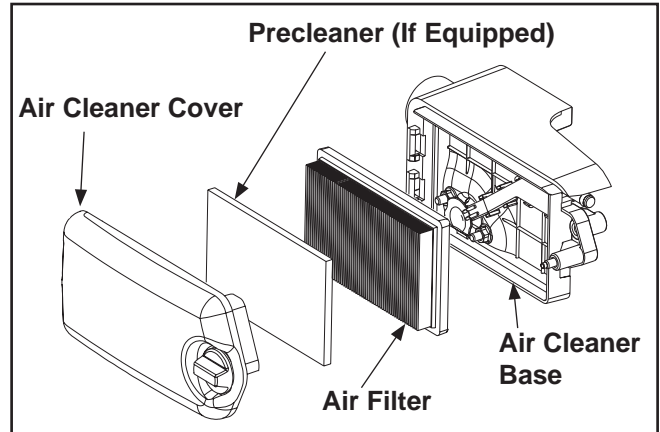

Figure 17. Air Cleaner Assembly – Exploded View.

Check the air cleaner daily or before starting the engine for a buildup of dirt and debris. Keep this area in and around the air cleaner clean. Also check for loose or damaged components. Replace all bent or damaged air cleaner components.

NOTE: Operating engine with loose or damaged air cleaner components could allow unfiltered air into engine, causing premature wear and failure.

Paper Air Filter

Yearly or every 100 hours of operation replace the paper air filter (Kohler part number 14 083 01-S). Check the paper filter for dirty, loose or damaged parts every 25 hours of operation; more often under extremely dusty or dirty conditions.

1. Remove the air cleaner cover, the paper air filter, and the precleaner, if equipped. See Figure 17.
2. Check the condition of the rubber seal on the filter. If the condition of the seal is questionable in any way, replace the filter.
3. Do not wash the paper filter or use pressurized air, as this will damage the filter.
4. When servicing the filter, also check the air cleaner base and cover for damage. All air cleaner components should fit properly. Replace all questionable air cleaner components.

5. If any debris fell into the air cleaner when the filter was removed, carefully remove and wipe the base clean.
6. Reinstall the paper filter and the optional precleaner (if equipped).
7. Reinstall the air cleaner cover and tighten the knob securely.
8. When replacement is necessary, use genuine Kohler parts.

Foam Air Filter

Yearly or every 100 hours of operation replace the foam air filter (**Kohler part number 14 083 09-S**). Check the foam filter for dirty, loose or damaged parts every 25 hours of operation; more often under extremely dusty or dirty conditions.

1. Remove the air cleaner cover, the foam air filter, and the precleaner, if equipped. See Figure 17.
2. Check the condition of the foam filter and the rubber seal on the filter. If the condition of the filter or the seal is questionable in any way, replace the filter.
3. When replacement is necessary, use genuine Kohler parts.
4. When servicing filter, also check the air cleaner base and cover for damage. All air cleaner components should fit properly. Replace all questionable air cleaner components.
5. If any debris fell into the air cleaner when the filter was removed, carefully remove and wipe the base clean.
6. Reinstall the foam filter, the air cleaner cover and tighten the knob securely.

Precleaner

1. Wash or replace the optional precleaner (**Kohler part number 14 083 02-S**) yearly or every 25 hours of operation; more often under extremely dusty or dirty conditions.
2. Loosen the air cleaner cover knob and remove the cover. See Figure 17.
3. Remove the precleaner and wash with detergent in warm water.
4. Rinse the precleaner thoroughly until all traces of detergent are eliminated. Squeeze out excess water (do not wring), and allow the precleaner to air dry.
5. Reinstall the precleaner.
6. Reinstall the air cleaner cover and tighten the knob securely.
7. When replacement is necessary, use genuine Kohler parts.

Cooling Areas

To ensure proper cooling, make sure the grass screen, cooling fins, and other external surfaces of the engine are kept clean at all times.

NOTE: Operating the engine with a blocked grass screen, dirty, or plugged cooling fins will cause engine damage due to overheating.

Spark Plug

Yearly or every 100 hours of operation, remove the spark plug, check its condition and reset the gap or replace with a new plug as necessary. The standard spark plug for model XT-6 is a Champion® 8815 (**Kohler part number 14 132 06-S**). The standard spark plug for models XT-7 and XTR-7 is a Champion® RC12YC (**Kohler part number 12 132 02-S**). Equivalent, alternative brand plugs can also be used.

1. Before removing the spark plug, clean the area around the base of the plug to keep dirt and debris out of the engine.
2. Remove the plug and check its condition. Replace the plug if worn or reuse is questionable.
3. Check the gap using a feeler gauge. See Figure 18.

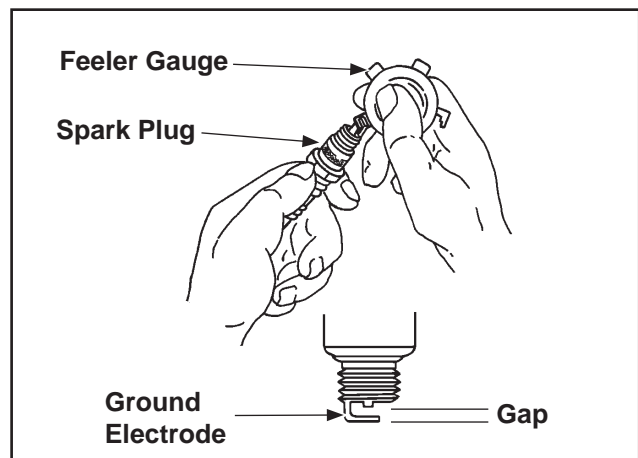

Figure 18. Spark Plug Gap.

NOTE: Do not clean the spark plug in a machine using abrasive grit. Some grit could remain in the spark plug and enter the engine causing extensive wear and damage.

4. Adjust the gap by carefully bending the ground electrode. Gap spark plug to **0.762 mm (0.030 in.)**. Reinstall the spark plug into the cylinder head. Torque the plug to **22-24 N·m (16-18 ft. lb.)**.

Ignition

This engine is equipped with a dependable maintenance-free ignition system. Other than periodically checking/replacing the spark plug, no adjustments are necessary or possible with this system.

In the event starting problems should occur which are not corrected by replacing the spark plug, see your Kohler Authorized Service Center.

Repairs

Repair information is available in Kohler Engine service manuals which are available online, or at Kohler Authorized Service Centers. Major repairs generally require the services of a trained mechanic and the use of specialized tools and equipment. Kohler Authorized Service Centers have the facilities, training, and genuine Kohler replacement parts necessary to perform these services.

For the nearest sales and service location, visit our Web site at www.KohlerEngines.com, or in the U.S. and Canada call 1-800-544-2444.

Parts Ordering

The engine model, specification, and serial numbers are required when ordering replacement parts from your Kohler Authorized Service Center. These numbers are found on the identification plate which is affixed to the engine shrouding. Include letter suffixes if there are any. See Engine Identification Numbers.

Always insist on genuine Kohler replacement parts, as they adhere to strict standards for fit, reliability, and performance. See Figure 19.

Kohler replacement parts for this engine include:

Part Description	Part Number
Foam Air Filter	14 083 09-S
Fuel Filter	14 050 16-S
Fuel Line	25 111 40-S
Paper Air Filter	14 083 01-S
Precleaner	14 083 02-S
Spark Plug XT-6	14 132 06-S
Spark Plug XT-7, XTR-7	12 132 02-S

Figure 19. Part List Table.

Engine Specifications¹

Model	XT-6	XT-7	XTR-7
Bore	65 mm (2.56 in.)	70 mm (2.75 in.)	70 mm (2.75 in.)
Stroke	45 mm (1.8 in.)	45 mm (1.8 in.)	45 mm (1.8 in.)
Displacement	149 cc (9.1 cu. in.)	173 cc (10.6 cu. in.)	173 cc (10.6 cu. in.)
Power @ 3600 RPM: kW (Net HP ²)	2.6 kW (3.5 HP)	3.4 kW (4.5 HP)	3.4 kW (4.5 HP)
Net Peak Torque @ 2600 RPM	8 N·m (5.9 ft. lbs.)	9.5 N·m (7 ft. lbs.)	9.5 N·m (7 ft. lbs.)
Compression Ratio	8.3:1	8.5:1	8.5:1
Weight	10.8 kg (24 lb.)	13.1 kg (29 lb.)	13.1 kg (29 lb.)
Fuel Capacity	1.1 L (3/10 gal.)	1.4 L (3/8 gal.)	1.4 L (3/8 gal.)
Oil Capacity (Refill)	0.60-0.65 L (20-22 oz.)	0.60-0.65 L (20-22 oz.)	0.60-0.65 L (20-22 oz.)
Lubrication	Splash	Splash	Splash
Charging System	—	—	0.5 Amp

Figure 20. Specifications Table.

¹Kohler Co. reserves the right to change product specifications, designs, and equipment without notice and without incurring obligation.

²Horsepower ratings exceed Society of Automotive Engineers Small Engine Test Code J1940. Actual engine horsepower is lower and affected by, but not limited to, accessories (air cleaner, exhaust, charging, cooling, fuel pump, etc.), application, engine speed, and ambient operating conditions (temperature, humidity, and altitude).

Exhaust Emission Control System for models XT-6, XT-7, XTR-7 is EM.

Troubleshooting

When problems occur, first check for simple reasons for a problem, for example, an empty fuel tank or the fuel shut-off valve is turned off. Additional troubleshooting tips can be found in Figure 21.

POSSIBLE CAUSE	PROBLEM									
	Will Not Start	Hard Starting	Stops Suddenly	Lacks Power	Operates Erratically	Knocks or Pings	Misfires or Backfires	Engine Overheats	Consumes Excess Fuel	Engine Smokes
No Fuel	●	●	●							
Engine Flooded	●	●					●			●
Fuel Valve Closed	●		●							
Faulty Spark Plug	●	●		●	●	●	●		●	●
Engine Runs Rich										●
Air Cleaner Blocked	●	●	●	●	●		●	●	●	
Debris in Fuel Line	●	●	●	●	●		●	●		
Cooling Areas Blocked			●	●	●	●	●	●		
Incorrect Oil Level	●	●	●	●				●		●
Engine Overloaded	●	●	●			●			●	
Wrong Fuel	●	●	●	●	●	●	●			
Discharged Battery	●									
Blown fuse	●		●							

Figure 21. Troubleshooting Table.

NOTE: Do not attempt to service or replace major engine components, or any items that require special timing or adjustment procedures. This work should be performed by a Kohler authorized service center.

Storage

If the engine will be out of service for two months or more, follow these storage procedures:

- Clean the exterior surfaces of the engine.
- Change the oil while the engine is still warm from operation. See Oil Change.
- The engine must be run until the fuel tank is completely emptied, or the gasoline must be treated with a stabilizer to prevent deterioration. If a stabilizer is used, follow the manufacturer's instructions. Fill the tank with fresh gasoline and run the engine for 2-3 minutes to ensure stabilized fuel has entered the carburetor.
- Remove the spark plug. Add one tablespoon of engine oil into the spark plug hole. Reinstall the plug, but do not connect the plug lead. Crank the engine two or three revolutions.
- Remove the spark plug. Cover the spark plug hole with your thumb and turn the engine over until the piston is at the top of its stroke (pressure against the thumb is greatest). Reinstall the spark plug, but do not connect the spark plug lead.
- Store the engine on a level surface in a clean, dry place. Never store the unit where there is an open flame, spark, or pilot light such as on a water heater or other appliances.

COURAGE® ENGINE LIMITED WARRANTY

Kohler Co. warrants to the original retail consumer that each new COURAGE® engine sold by Kohler Co. will be free from manufacturing defects in materials or workmanship in normal residential homeowner service for a period of two (2) years from date of purchase, provided it is operated and maintained in accordance with Kohler Co.'s instructions and manuals. If used commercially the COURAGE® engine is covered by a 90-day¹ limited warranty.

The warranty period begins on the date of purchase by the original retail consumer or commercial end user. "Residential homeowner service" means residential use by a retail consumer. "Commercial use" means all other uses, including use for commercial, or rental purposes. Once in commercial use, the engine will thereafter be considered a commercial use engine for the purposes of this warranty.

Our obligation under this warranty is expressly limited, at our option, to the replacement or repair at Kohler Co., Kohler, Wisconsin 53044, or at a service facility designated by us of such parts as inspection shall disclose to have been defective.

EXCLUSIONS:

Mufflers on engines used commercially (non-residential) are warranted for 90 days from date of purchase. This warranty does not apply to defects caused by casualty or unreasonable use, including faulty repairs by others and failure to provide reasonable and necessary maintenance.

The following items are not covered by this warranty: Engine accessories such as fuel tanks, clutches, transmissions, power-drive assemblies, and batteries, unless supplied or installed by Kohler Co. These are subject to the warranties, if any, of their manufacturers.

Kohler Co. AND/OR THE SELLER SHALL NOT BE LIABLE FOR SPECIAL, INDIRECT, INCIDENTAL, OR CONSEQUENTIAL DAMAGES OF ANY KIND, including but not limited to labor costs or transportation charges in connection with the repair or replacement of defective parts.

IMPLIED OR STATUTORY WARRANTIES, INCLUDING WARRANTIES OF MERCHANTABILITY OR FITNESS FOR A PARTICULAR PURPOSE, ARE EXPRESSLY LIMITED TO THE DURATION OF THIS WRITTEN WARRANTY. We make no other express warranty, nor is any one authorized to make any on our behalf.

Some states do not allow limitations on how long an implied warranty lasts, or the exclusion or limitation of incidental or consequential damages, so the above limitation or exclusion may not apply to you. This warranty gives you specific legal rights, and you may also have other rights which vary from state to state.

TO OBTAIN WARRANTY SERVICE:

Purchaser must bring the engine to an authorized Kohler service facility. To locate the nearest facility, visit our Web site, www.kohlerengines.com, and click on SERVICE AND SUPPORT to use the locator function, consult your Yellow Pages or telephone 1-800-544-2444.

ENGINE DIVISION, KOHLER CO., KOHLER, WISCONSIN 53044

EN

¹With the exception of countries governed by the European Union (EU), where a one (1) year warranty is required for commercial/professional use.

KOHLER CO.
FEDERAL AND CALIFORNIA EMISSION CONTROL SYSTEMS
LIMITED WARRANTY SMALL OFF-ROAD ENGINES

The U.S. Environmental Protection Agency (EPA), the California Air Resources Board (CARB), and Kohler Co. are pleased to explain the Federal and California Emission Control Systems Warranty on your small off-road equipment engine. In California beginning in 2006, "emissions" means both exhaust and evaporative emissions. For California, engines produced in 2006 and later must be designed, built and equipped to meet the state's stringent anti-smog standards. In other states, 1997 and later model year engines must be designed, built and equipped, to meet the U.S. EPA regulations for small non-road engines. The engine must be free from defects in materials and workmanship which cause it to fail to conform with U.S. EPA standards for the first two years of engine use from the date of sale to the ultimate purchaser. Kohler Co. must warrant the emission control system on the engine for the period of time listed above, provided there has been no abuse, neglect or improper maintenance.

The emission control system may include parts such as the carburetor or fuel injection system, the ignition system, and catalytic converter. Also included are the hoses, belts and connectors and other emission related assemblies.

Where a warrantable condition exists, Kohler Co. will repair the engine at no cost, including diagnosis (if the diagnostic work is performed at an authorized dealer), parts and labor.

MANUFACTURER'S WARRANTY COVERAGE

Engines produced in 2006 or later are warranted for two years in California. In other states, 1997 and later model year engines are warranted for two years. If any emission related part on the engine is defective, the part will be repaired or replaced by Kohler Co. free of charge.

OWNER'S WARRANTY RESPONSIBILITIES

- (a) The engine owner is responsible for the performance of the required maintenance listed in the owner's manual. Kohler Co. recommends that you retain all receipts covering maintenance on the engine, but Kohler Co. cannot deny warranty solely for the lack of receipts or for your failure to assure that all scheduled maintenance was performed.
- (b) Be aware, however, that Kohler Co. may deny warranty coverage if the engine or a part has failed due to abuse, neglect, improper maintenance or unapproved modifications.
- (c) For warranty repairs, the engine must be presented to a Kohler authorized service center as soon as a problem exists. Call Kohler Co. toll free at 1-800-544-2444, or access our Web site at www.kohlerengines.com for the names of the nearest service centers. Warranty repairs should be completed in a reasonable amount of time, not to exceed 30 days.

If you have any questions regarding warranty rights and responsibilities, you should contact Kohler Co. at 1-920-457-4441 and ask for an engine service representative.

COVERAGE

Kohler Co. warrants to the ultimate purchaser and each subsequent purchaser that the engine will be designed, built and equipped, at the time of sale, to meet all applicable regulations. Kohler Co. also warrants to the initial purchaser and each subsequent purchaser, that the engine is free from defects in materials and workmanship which cause the engine to fail to conform with applicable regulations for a period of two years.

Engines produced in 2006 or later are warranted for two years in California. For 1997 and later model years, EPA requires manufacturers to warrant engines for two years in all other states. These warranty periods will begin on the date the engine is purchased by the initial purchaser. If any emission related part on the engine is defective, the part will be replaced by Kohler Co. at no cost to the owner. Kohler Co. is liable for damages to other engine components caused by the failure of a warranted part still under warranty.

Kohler Co. shall remedy warranty defects at any authorized Kohler Co. engine dealer or warranty station. Warranty repair work done at an authorized dealer or warranty station shall be free of charge to the owner if such work determines that a warranted part is defective.

Continued on the next page.

Listed below are the parts covered by the Federal and California Emission Control Systems Warranty. Some of the parts listed may require scheduled maintenance and are warranted up to the first scheduled replacement point for that part. The warranted parts include the following if they were present in the engine purchased:

- Oxygen sensor (if equipped)
- Intake manifold (if equipped)
- Exhaust manifold (if equipped)
- Catalytic muffler (if equipped)
- Thermal reactor muffler (if equipped)
- Spark advance module (if equipped)
- Air filter, fuel filter, and spark plugs (only to first scheduled replacement point)
- Crankcase breather
- Air injection system (if equipped)
 - Air pump or pulse valve assembly (if equipped)
 - Control/distribution valve (if equipped)
 - Distribution manifold (if equipped)
 - Air hoses (if equipped)
 - Vacuum lines (if equipped)
- Ignition module(s) with high tension lead
- Gaseous fuel regulator (if equipped)
- Electronic control unit (if equipped)
- Carburetor or fuel injection system (if equipped)
- Fuel lines, fuel line fittings and clamps (if equipped)
- Fuel metering valve (if equipped)
- Evaporative system (if equipped)
 - Canister (if equipped)
 - Canister filter (if equipped)
 - Vapor hose (if equipped)
 - Orifice connector (if equipped)
 - Fuel tank (if equipped)
 - Fuel cap (if equipped)
 - Primer bulb canister (if equipped)

LIMITATIONS

This Emission Control System Warranty shall not cover any of the following:

- (a) Repair or replacement required because of misuse or neglect, improper maintenance, improper repairs, or replacements not conforming to Kohler Co. specifications that adversely affect performance and/or durability and alterations or modifications not recommended or approved in writing by Kohler Co.,
- (b) Replacement of parts and other services and adjustments necessary for required maintenance at and after the first scheduled replacement point,
- (c) Consequential damages such as loss of time, inconvenience, loss of use of the engine or equipment, etc.,
- (d) Diagnosis and inspection fees that do not result in eligible warranty service being performed, and
- (e) Any add-on or modified part, or malfunction of authorized parts due to the use of add-on or modified parts.

MAINTENANCE AND REPAIR REQUIREMENTS

The owner is responsible for the proper use and maintenance of the engine. Kohler Co. recommends that all receipts and records covering the performance of regular maintenance be retained in case questions arise. If the engine is resold during the warranty period, the maintenance records should be transferred to each subsequent owner. Kohler Co. reserves the right to deny warranty coverage if the engine has not been properly maintained; however, Kohler Co. may not deny warranty repairs solely because of the lack of repair maintenance or failure to keep maintenance records.

Normal maintenance, replacement or repair of emission control devices and systems may be performed by any repair establishment or individual; however, **warranty repairs must be performed by a Kohler authorized service center**. Any replacement part or service that is equivalent in performance and durability may be used in non-warranty maintenance or repairs, and shall not reduce the warranty obligations of the engine manufacturer.

KOHLER® ENGINES

FOR SALES AND SERVICE INFORMATION
IN U.S. AND CANADA, CALL 1-800-544-2444

KohlerEngines.com

ENGINE DIVISION, KOHLER CO., KOHLER, WISCONSIN 53044

FORM NO.: 14 590 02
ISSUED: 1/09
REVISED:



1P14 590 02



6 50531 85194 9